

Honeywell

LNx Series

Mobile Printers



User Guide

Disclaimer

Honeywell International Inc. ("HII") reserves the right to make changes in specifications and other information contained in this document without prior notice, and the reader should in all cases consult HII to determine whether any such changes have been made. HII makes no representation or warranties regarding the information provided in this publication.

HII shall not be liable for technical or editorial errors or omissions contained herein; nor for incidental or consequential damages resulting from the furnishing, performance, or use of this material. HII disclaims all responsibility for the selection and use of software and/or hardware to achieve intended results.

This document contains proprietary information that is protected by copyright. All rights are reserved. No part of this document may be photocopied, reproduced, or translated into another language without the prior written consent of HII.

Copyright © 2023 Honeywell Group of Companies. All rights reserved.

Web Address: sps.honeywell.com

Android is a trademark of Google LLC.

Bluetooth trademarks are owned by Bluetooth SIG, Inc., U.S.A. and licensed to Honeywell.

Windows is a registered trademark of the Microsoft group of companies.

iOS is a trademark or registered trademark of Cisco in the U.S. and other countries

Other product names or marks mentioned in this document may be trademarks or registered trademarks of other companies and are the property of their respective owners.

For patent information, refer to www.hsmpats.com.

TABLE OF CONTENTS

Customer Support	v
Technical Assistance	v
Product Service and Repair	v
Limited Warranty	v
Chapter 1 - Get Started	1
Introduction	1
Features	1
Front View	2
Back View	2
About the User Interface	2
Buttons	3
Display Icons	3
Status Indicator	4
Audible Indicator	4
About the Battery	4
Before Charging for the First Time	5
Replace the Battery	5
Charge the Battery	6
Battery Recommendations and Safety Precautions	7
Printer Command Languages	8
Printer Configuration	9
Chapter 2 - Set Up the Printer	11
Configure the Media	11
Load Labels or Paper	12

Print a Test Label	13
Chapter 3 - Connect the Printer	15
Printer Drivers	15
USB Connection	15
Bluetooth Connection.....	15
Wireless 802.11 (model dependent).....	16
Chapter 4 - Configure the Printer	17
Printer Configuration Menus	17
Print Settings	18
Device Config.....	18
Bluetooth.....	19
WiFi (model dependent).....	19
About.....	20
Self Test Page.....	20
Printer Web Page (Model Dependent)	20
Obtain Printer IP Address	20
Configure the Printer from the Web Page	21
Chapter 5 - Troubleshooting	23
System Information	23
Troubleshoot Printer Problems	23
Chapter 6 - Maintenance	25
Software and Firmware	25
Software Downloads	25
Firmware Upgrades	26
Restore Factory Defaults	26
Clean the Printer	26
Clean the Printhead	27
Clean the Sensor	28
Clean the Rubber Roller.....	28

Chapter 7 - Specifications and Additional Resources31

- Printer and Environmental Specifications.....31
- Media Specifications31
- Supported Command Languages.....31
- Barcode Symbologies.....32
 - CPCL.....32
 - ESC/P.....32
 - ESC/POS.....33
 - XSim.....33
 - ZPL34
- Graphic File Types.....35
 - CCPL.....35
 - ESC/P.....35
 - ESC/POS.....35
 - XSim.....35
 - ZPL35
- Character Sets35
 - CPCL.....35
 - ESC/P (Easy Print, Line Print).....35
 - ESC/POS.....36
 - XSim.....36
 - ZPL-II.....36
- Required Safety Labels.....36

Customer Support

Technical Assistance

To search our knowledge base for a solution or to log in to the Technical Support portal and report a problem, go to honeywell.com/PSStechnicalsupport.

Product Service and Repair

Honeywell International Inc. provides service for all of its products through service centers throughout the world. Go to sps.honeywell.com and select **Support > Productivity** to find a service center near you or to get a Return Material Authorization number (RMA #) before returning a product.

Limited Warranty

For warranty information, go to sps.honeywell.com and select **Support > Productivity > Warranties**.

Introduction

LNX mobile label and receipt printers are durable, light-weight thermal printers with USB, Bluetooth® Technology, and Wi-Fi LAN (model-dependent).

- Compact enough to carry or wear
- Equipped with seamless Bluetooth connectivity and Wi-Fi (model-dependent)
- Leading print speeds up to 5ips
- Support large-volume label and receipt printing
- Equipped with a long-lasting 2800mAH battery with hotswap capabilities
- Effortlessly connect with NFC pairing, Bluetooth and Wi-Fi options
- Print from almost any device with Windows®, iOS®, and Android® compatibility

To print labels or receipts, refer to the instructions included with the software used to create the labels.

Features

- High-speed printing
- Long-life battery
- Rugged casing
- User-friendly color LCD screen
- Multi programming languages supported including ZPL, CPCL, ESC/POS, XSIM, and ESC/P

Front View

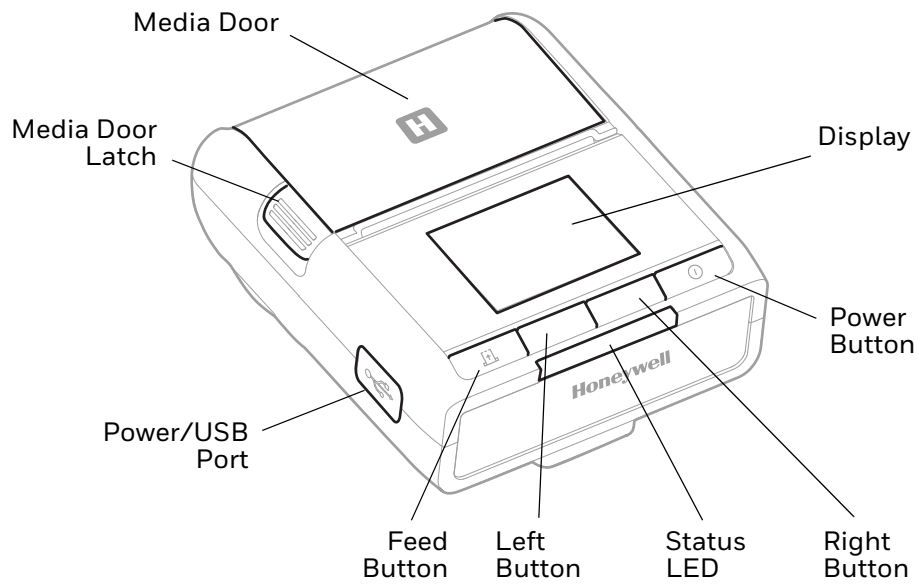

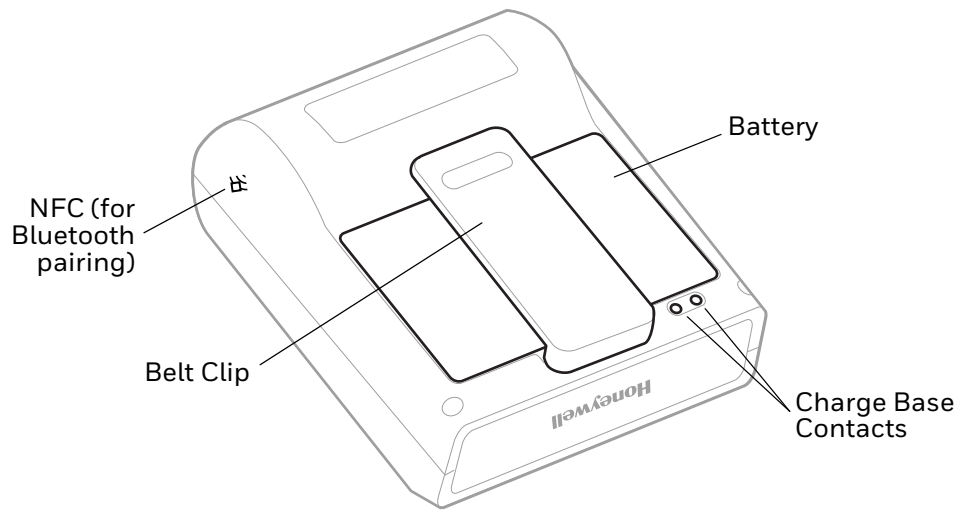

Back View















About the User Interface







The LNX user interface includes an LCD display as well as manual buttons for printer functions and navigating the display menu.

Buttons

Button	Action	Result
(any)	Short press (when printer is in Sleep mode)	Wake printer and activate display.
 On/Off	Press (when printer is off)	Turn printer on.
	Long press (when printer is on)	Turn printer off. Note: The printer will not turn off when connected to a power supply or if the display menu is active.
	Short press (when display is active)	Result is determined by the icon on the user display (refer to the Display Icons table).
 Feed	Press (when display is idle)	Feed label or paper length.
	Press (when display is active)	Result is determined by the icon on the user display (refer to the Display Icons table).
Left	Press (when display is active)	Open the main menu, or move between menu options and settings.
Right	Press (when display is active)	Move between menu options and settings.

Display Icons

Icon	Description
	Power
	Media feed
	Menu
	Battery charge level
	Battery charging
	Battery less than 20%
	Out of battery
	About to shut down
	No media
	Left/Right
	Up/Down
	Back
	Edit

Icon	Description
+	Add
—	Minus
✓	Confirm
✕	Cancel
	Printing in progress
	Bluetooth connected
	Wi-Fi connected
	Media door open
	Overheat warning
	Seam calibration error
	Learn error

To learn about menu options, see [Configure the Printer](#), beginning on page 17.

Status Indicator

State	Description
Red (when display is idle)	Printer is in Sleep mode.
Red (when display is active)	Alert (for example: media door is open, media is out, battery is low, or an error has occurred).

Audible Indicator

Beeps	Description
2 short beeps	Event notification (for example: printer has been turned on, battery charge is complete, firmware update is complete, media door is open, media is out, battery is low, or an error has occurred).

About the Battery

Power is supplied to the printer by a rechargeable lithium ion battery. Batteries are shipped only partially charged. The battery should be charged for a minimum of 4 hours before initial use to ensure optimal performance.

Before Charging for the First Time

The printer is shipped with a battery installed. However, when using the printer for the first time, you must remove the protective film from the battery contacts before charging the printer. Refer to the next section for instructions on how to remove the battery.

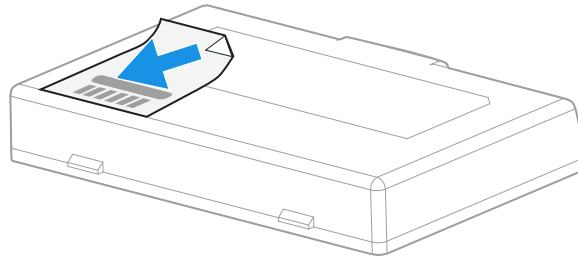

Battery

Replace the Battery

1. Power off the printer.
2. Rotate the belt clip on the back of the printer to access the battery.

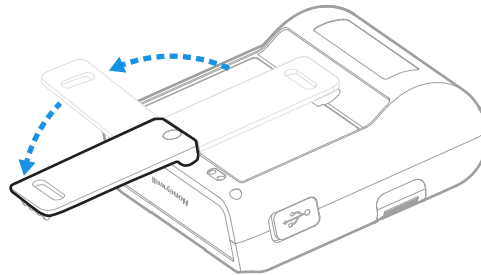

3. Press the latch and remove the battery.

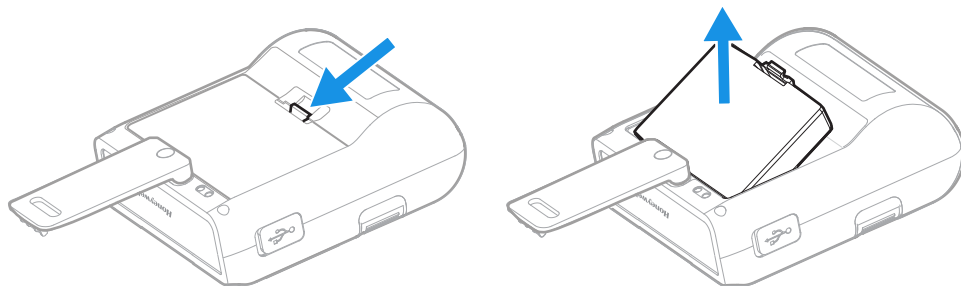

4. Insert the battery into the printer and push down until the latch clicks.

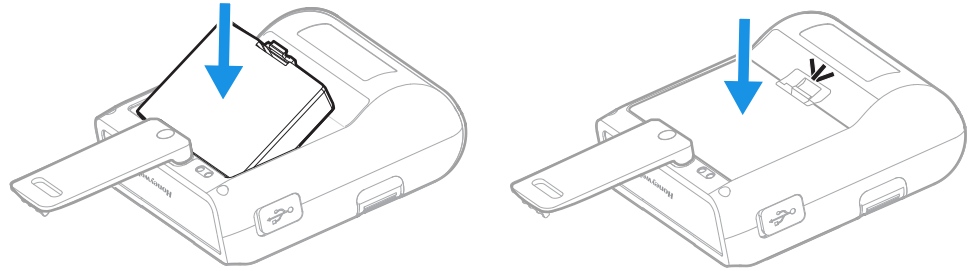

5. Rotate the belt clip back into position.

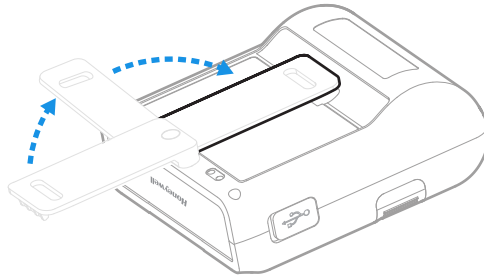

Hot Swap

You can replace the battery on demand provided the following condition is met:

- You insert a new battery within 60 seconds.

Charge the Battery

Before you attempt to use, charge or replace the battery in the mobile computer, carefully read all the information under [Battery Recommendations and Safety Precautions](#) on page 7.

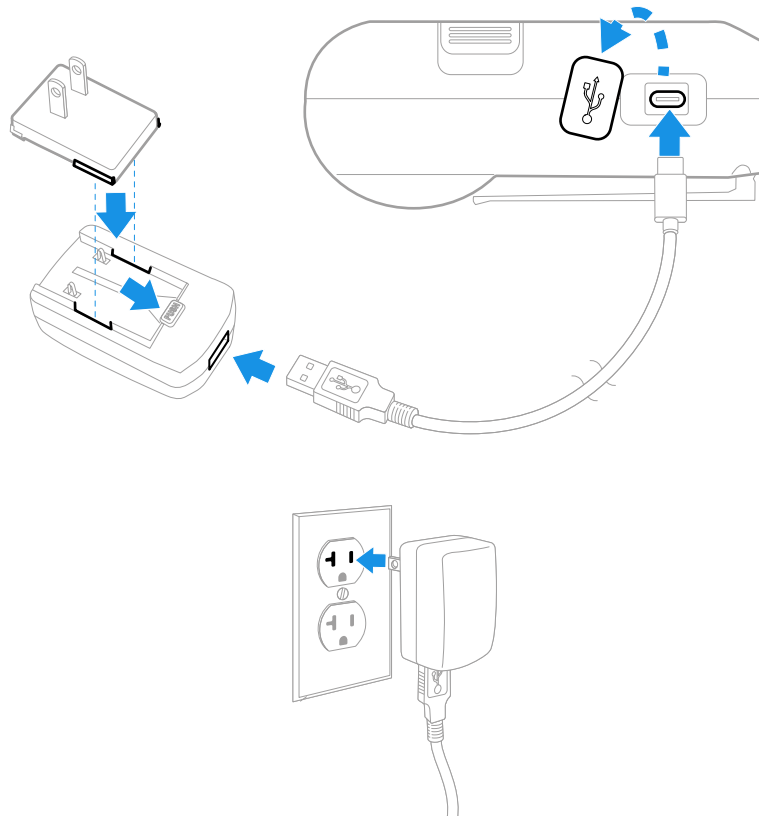

Battery Recommendations and Safety Precautions



Caution: The maximum operating temperature of the printer is 55°C (131°F); however the maximum operating temperature for charging when used with a Honeywell power supply is limited to 40°C (104°F). Charge the printer in a location that meets this temperature requirement.



Caution: Improper battery replacement or incompatible device usage may result in risk of burns, fire, explosion, or other hazard. Dispose of lithium-ion batteries according to local regulations. Risk of fire and burns if improperly handled. Do not open, crush, heat above 70°C (158°F), or incinerate.

- To learn more about Battery Maintenance for Portable Devices, go to [honeywell.com/PSS-BatteryMaintenance](https://www.honeywell.com/PSS-BatteryMaintenance).
- Do not store the battery pack at temperatures above 60°C (140°F). Storage above 60°C (140°F) may damage the battery pack.
- Charge the battery before use. Battery ships with only a partial charge.
- Use of this battery in other devices could result in damage to the device or battery.

- Avoid dropping the battery or printer. If you suspect that the battery or printer is damaged, send it to a Honeywell service center for inspection.
- Replace the battery only with another LNX3-BAT model battery. These batteries have been tested in accordance with applicable safety standards. Contact your Honeywell sales representative or distributor if the battery is no longer available.
- Discarded batteries may create a safety hazard. Before disposal, cover the battery contacts with electrical insulating tape.
- Do not modify the battery or attempt to insert foreign objects into it.
- Do not solder directly to the battery contacts.
- Do not drop the battery or apply mechanical shocks or pressure to it.
- Do not immerse batteries into, or expose them to water or seawater.
- Do not incinerate, microwave, throw into a fire, or expose batteries to temperatures above the maximum rating.
- Do not disassemble a battery or try to open or penetrate its housing.
- Do not remove the battery when charging.
- When storing the printer for an extended time, remove the battery and store it separately.

Printer Command Languages

A printer command language is a set of instructions that controls printer functions such as:

- Configuring the printer
- Returning the status of the printer
- Creating labels and receipts for printing

Note: *For more information, see the command reference manual for your desired language.*

LNX printers support the following command languages:

- ZPL
- CPCL
- ESC/POS
- XSIM
- ESC/P







Command Language can be set using the printer user interface (see [Print Settings](#), beginning on page 18).

Printer Configuration

Use one of these methods to view and change printer settings:

- Printer user interface (see page [17](#))
- YuShi Printer Tool, available from the [Software Downloads portal](#) (see page [25](#))
- Printer web page (model dependent, see page [20](#))
- Command language

Configure the Media

1. With the printer on, press any button to activate the display.
2. Press the left button to open the interface menu. **Print Settings** is the default menu option.
3. Press the  button to access Print Settings.
4. Use the right button to navigate to **PAPER WIDTH**.
5. Press the  button to edit.
6. Use the left or right button to select the desired width.
7. Press the  button to confirm the change.
8. Press the  button to return to the Print Settings menu.
9. Use the right button to navigate to **MEDIA TYPE**.
10. Press the  button to edit.
11. Use the left or right button to select the desired media type.
12. Press the  button to confirm the change.

Load Labels or Paper

1. Press down on the latch to open the media door.

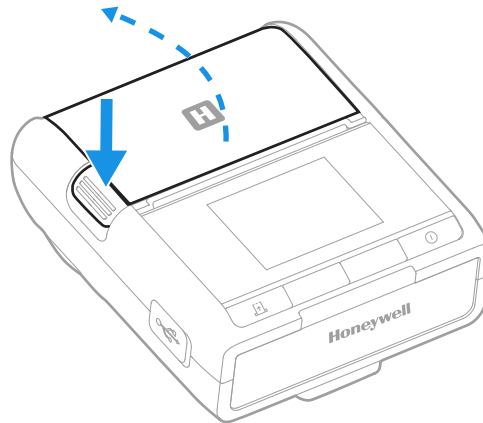

2. Slide and hold open the supply hubs while inserting the media as shown:

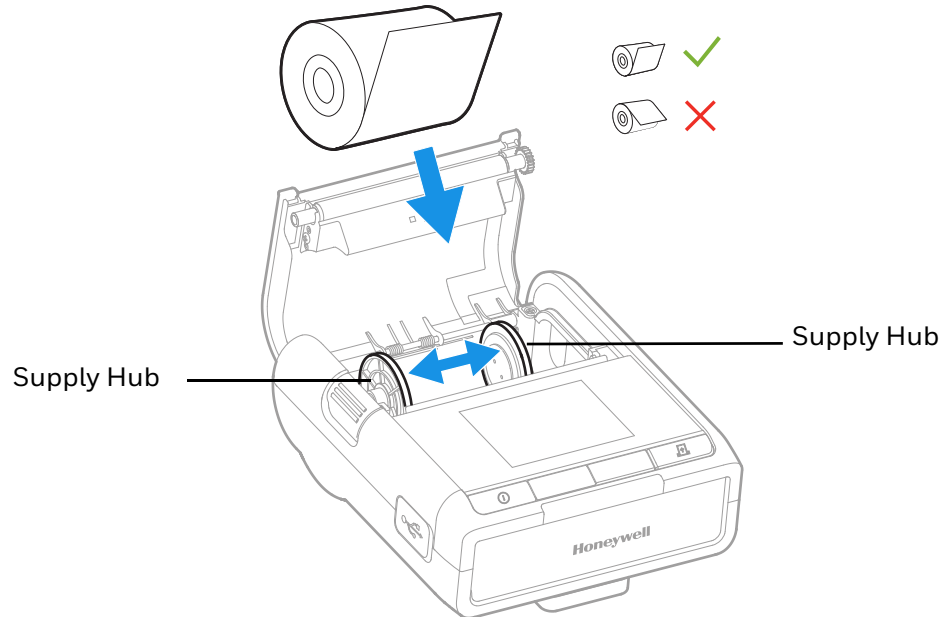

3. Allow the supply hubs to retract onto the media roll.

4. Press the door down until it latches.

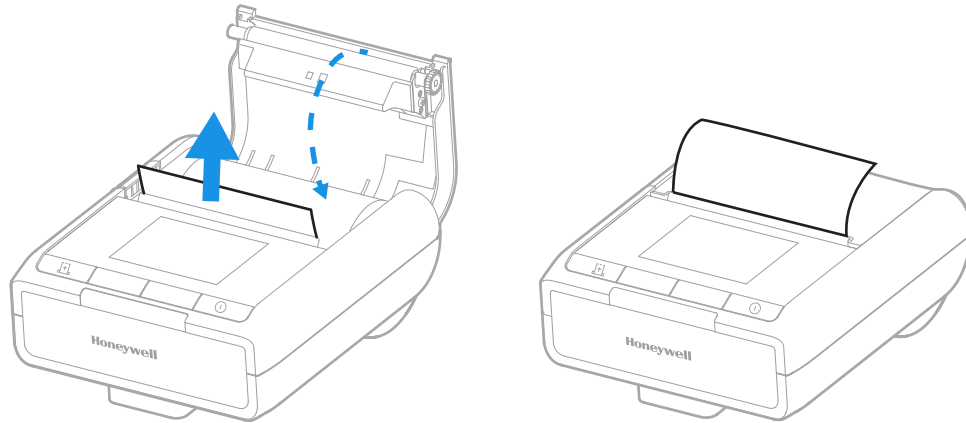

Print a Test Label

Print a test label after you have loaded the media to verify that you have installed everything correctly and also to get some important information about your printer.

1. With the printer on, press any button to activate the display.
2. Press the left button to open the display menu.
3. Use the right button to navigate to **SELFTEST PAGE**.
4. Press **ⓘ** select.
5. Press **ⓘ** to confirm

Note: Use only original or approved paper.

Note: The storage time of receipts is related to the quality of the thermal paper used. Use thermal paper with a retention period that meets your storage time requirements.

CONNECT THE PRINTER

You can communicate with the host via USB connection, Bluetooth connection or Wireless 802.11 (model-dependent).

Printer Drivers

Drivers enable the printer to communicate with your PC and with printer software applications. A Windows driver for the LNX printers is available from the download portal from the Software Downloads portal ([honeywell.com/PSSsoftware-downloads](https://www.honeywell.com/PSSsoftware-downloads)). For more information about the downloads portal, see [Software and Firmware](#), beginning on page 25.

USB Connection

LNX printers ship with a standard USB C to USB A cable. You can use a USB connection for both transmitting data and charging the printer.

1. Connect the USB cable to the printer and to the USB port on the host system.
2. Power up the printer.
3. Your host computer should recognize the printer and begin adding the device driver.

If the setup operation does not start in Windows, locate the **Devices and Printers** section in the Control Panel and select **Add a Printer**. Then select the printer model.

Once setup is complete, you should see the available printer on your host PC.

Bluetooth Connection

Follow your host PC or device instructions for pairing a new Bluetooth device. You should see the printer as an available printer from your host. Select your printer to pair with your host PC.

To view your printer's Bluetooth pin code:

1. With the printer on, press any button to activate the display.
2. Press the left button to open the display menu.
3. Use the right button to navigate to the **BLUETOOTH** menu.
4. Press the **ⓘ** button to select the menu.
5. Navigate to **Pin Code**.

For more information about configuring Bluetooth settings on your LNX printer, see page [19](#).

Note: *The Bluetooth pin code will also print on a self test page (see page [20](#)).*

Wireless 802.11 (model dependent)

LYNX3-1 models support wireless 802.11 communication and can use several wireless LAN security protocols.

To configure wireless network settings, connect the printer via USB and use the YuShi Printer Tool. (Refer to the YuShi Printer Tool User Guide.)

For more information about the Wireless menu on your LNX printer's user interface, see page [19](#).

CONFIGURE THE PRINTER

Use one of these methods to view and change printer settings:

- Printer user interface
- YuShi Printer Tool (refer to the YuShi Printer Tool User Guide)
- Printer web page
- Programming commands





Printer Configuration Menus

To access the menus on the printer user interface:

1. With the printer on, press any button to activate the display.
2. Press the left button to open the display menu.
3. Use the left and or right buttons to navigate to the desired menu.
4. Press the  button to select the menu option.

Note: If **Device Config > Password** is enabled, some settings will require a password to change.

There are six configuration menus:

Menu	Description
 Print Settings	View or change printer settings, such as paper width, darkness, media type, print speed and command set.
 Device Config	Set sleep mode, password, and other settings as well as restore factory defaults.
 Bluetooth	View Bluetooth information.
 WiFi	View WiFi connection information.
 About	View the printer's serial number, firmware version, print mileage, and battery voltage.

Menu	Description
 Self Test Page	Print a self test page.

Print Settings

Use the **Print Settings** menu to view or change the following options:

Setting	Description	Default
Darkness	Sets the printing density. Enter a print density value of 1-15 for the best quality print for the media in use.	8
Paper Width	Defines the size of the media to be used. The Custom setting is configurable from 43-80mm.	3 inch mode: 80mm
Command Set	Selects the command language to be used.	ZPL
Media Type	Selects the type of media that is loaded in the printer: <ul style="list-style-type: none"> Receipt Label Black Mark 	Label
Speed	Sets how fast the printer prints in inches per second (ips).	4
Menu Language	Displays the language of the user interface.	English

Device Config

Use the **Device Config** menu to view or change the following options:

Setting	Description	Default
Sleep Mode Timeout	Sets the number of seconds the display remains active before entering sleep mode.	99 s
Password	Enables or disables whether a password is required for changing certain settings (such as this one). The default password is 9999.	Enable
Restore Factory Setting	Resets the printer to factory defaults (see page 26).	
Other	Accesses additional device configuration options.	
Buzzer Switch	Enables or disables the audible indicator (see page 4). Select Open for On or Close for Off.	Open
USB Device Type	Defines how the printer communicates with a host computer. To connect to a serial port, select USB Virtual COM Port.	USB Printer
Power On With Feed	Determines whether the paper automatically advances when the printer is powered on. Select Open for On or Close for Off.	Close
Cover With Feed	Determines whether the paper automatically advanced when the media door is opened then closed. Select Open for On or Close for Off.	Close

Bluetooth

Use the **Bluetooth** menu to view or change the following options:

Setting	Description	Default
MAC	Displays the printer's MAC address.	
Name	Displays the printer's name for pairing.	
Pin Code	Display or change the printer's Bluetooth pin code for pairing.	000000
Connection Status	Displays the printer's Bluetooth connection state.	
Discoverable	Determines whether the printer is discoverable for pairing via Bluetooth technology.	Enable
Multi-Connection	Determines whether multiple Bluetooth connections to the printer are allowed.	Disable
Version	Displays the Bluetooth module firmware version.	
Bluetooth Spec	Displays the Bluetooth version of the printer.	
Mode	Displays the relationship of the printer to a paired device.	Slave

For information about connecting with Bluetooth technology, see page [15](#).

WiFi (model dependent)

LNX-1 printers: Use the **WiFi** menu to view or change the following options:

Setting	Description	Default
MAC	Displays the MAC address of the printer.	
Version	Displays the Wi-Fi version on the printer.	
Connection status	Displays the printer's Wi-Fi connection state.	
Select Mode	Determines whether the printer acts as a Station (STA) or Access Point (AP).	STA
Mode Detail	Accesses additional Wi-Fi options.	
DHCP	(STA mode only) Determines whether the printer obtains an IP address automatically via DHCP. Select Open for On or Close for Off.	Close
SSID	Displays the wireless network's name.	
Secure Type	Displays the wireless network's security protocol (e.g., WPA, WPA2)	
IP address	Display or edit the unique network-level address that is assigned to the printer.	192.168.1.87
Port	(STA mode only) Displays the port.	9100
Subnet Mask	(STA mode only) Specifies a number that defines the range of IP addresses that can be used in a TCP/IP network.	255.255.255.0
Gateway	(STA mode only) Specifies the router's IP address,	192.168.1.1

For information about connecting to a wireless network, see page 16.

About

Use the About menu to view the following information:

Setting	Description
SN	Displays the printer's serial number.
Firmware Version	Displays the current firmware version installed on the printer.
Print Mileage	Displays the number of meters of media the device has printed.
Battery Voltage	Displays the voltage of the printer's battery.

Self Test Page

To print a test page:

1. With the printer on, press any button to activate the display.
2. Press the left button to open the display menu.
3. Use the right button to navigate to **SELFTEST PAGE**.
4. Press the **I** button to select the menu option.
5. Press the **I** button again to confirm.

The self test page will print with information about the printer such as model and serial numbers, print density and speed, the command set, media type, paper width, TPH temperature, main and backup battery voltage, DPI, print mileage and Bluetooth information.

Printer Web Page (Model Dependent)

For LNX-1 printers, use this procedure to configure wireless communications from the printer web page.

Note: *The printer must be turned on and connected to your Wi-Fi network to configure the printer from the web page.*

Obtain Printer IP Address

1. With the printer on, press any button to activate the display.
2. Press the left button to open the display menu.
3. Use the right button to navigate to the **WIFI** menu, then press the **I** button.
4. Navigate to **Mode Details**, then press the **I** button.

5. Navigate to **IP Address**.

Configure the Printer from the Web Page

1. Open a web browser on your PC.
2. In the address bar, type *https://* followed by the printer IP address (see previous section) and press Enter. The printer web page appears.
3. Change the desired setting(s):

Setting	Description
PRINTER INFO	
Mode	The printer's model number.
SN	Displays the printer's serial number.
Firmware Version	Displays the current firmware version installed on the printer.
Printer Status	The current state of the printer.
Print Mileage	Displays the number of meters of media the device has printed.
Battery Voltage	Displays the voltage of the printer's battery.
PRINT SETTINGS	
Darkness	Sets the printing density. Enter a print density value of 1-15 for the best quality print for the media in use.
Paper Width	Defines the size of the media to be used. The Custom setting is configurable from 43-80mm.
Command Language	Selects the command language to be used.
Media Type	Selects the type of media that is loaded in the printer: <ul style="list-style-type: none"> • Receipt • Label • Black Mark
Print Speed	Sets how fast the printer prints in inches per second (ips).
DEVICE CONFIG	
Sleep Mode Timeout	Sets the number of seconds the display remains active before entering sleep mode.
Password	Enables or disables whether a password is required for changing certain settings (such as this one). The default password is 9999.
Restore Factory Setting	Resets the printer to factory defaults.
Buzzer Switch	Enables or disables the audible indicator (see page 4). Select Open for On or Close for Off.
USB Device Type	Defines how the printer communicates with a host computer. To connect to a serial port, select USB Virtual COM Port.
Power On With Feed	Determines whether the paper automatically advances when the printer is powered on. Select Open for On or Close for Off.
Cover With Feed	Determines whether the paper automatically advanced when the media door is opened then closed. Select Open for On or Close for Off.

Setting	Description
BLUETOOTH	
MAC Address	Displays the printer's MAC address.
Name	Displays the printer's name for pairing.
Pin Code	Display or change the printer's Bluetooth pin code for pairing.
Connected Status	Displays the printer's Bluetooth connection state.
Discoverable	Determines whether the printer is discoverable for pairing via Bluetooth technology.
Multi-connection	Determines whether multiple Bluetooth connections to the printer are allowed.
Reserve Mode	Enables or disables Reserve Mode
Version	Displays the Bluetooth module firmware version.
Bluetooth Spec	Displays the Bluetooth version of the printer.
Wi-Fi	
MAC Address	Displays the MAC address of the printer.
Version	Displays the Wi-Fi version on the printer.
STA Mode's DHCP	Determines whether the printer obtains an IP address automatically via DHCP when the printer is in STA (station) mode. Select Open for On or Close for Off.
STA Mode's SSID	Displays the wireless network's name when the printer is in STA mode.
STA Mode's Secure Type	Display's the wireless network's security protocol (e.g., WPA, WPA2) used in STA mode.
STA Mode's IP Address	Display or edit the unique network-level address that is assigned to the printer in STA mode.
STA Mode's Subnet Mask	Specifies a number that defines the range of IP addresses that can be used in a TCP/IP network when the printer is in STA mode.
STA Mode's Gateway	Specifies the router's IP address when the printer is in STA mode,
STA Mode's Port	Displays the port use in STA mode.
AP Mode's SSID	Displays the wireless network's name when the printer is in STA mode.
AP Mode's IP	Display or edit the unique network-level address that is assigned to the printer in STA mode.
AP Mode's Secure Type	Display's the wireless network's security protocol (e.g., WPA, WPA2) used in STA mode.
SELFTTEST PAGE	
Selftest Page	Print a self test page.

4. Click **SUBMIT**.

System Information

Access the **About** menu for useful information on the printer mileage, hardware and firmware.

1. With the printer on, press any button to activate the display.
2. Press the left button to open the display menu.
3. Use the right button to navigate to **ABOUT**.
4. Press the **i** button.
5. Use the left and right buttons to navigate through the options.

Troubleshoot Printer Problems

Use this section to find possible solutions to printer problems.

Problem	Possible Solution
Print is blurry.	Clean the printhead (see page 27) and/or rubber roller (see page 28).
	When using colored paper, set the darkness higher (see page 18) or use lighter-colored paper.
Loud paper feed noise.	Clean the printhead (see page 27) and/or rubber roller (see page 28).
Printer occasionally stops printing and the audible alert sounds as if the paper has run out.	Clean the sensor (see page 28)
Audible alert for paper outage does not sound.	Clean the sensor (see page 28)
Printout is blank.	The media may be installed upside down. Remove the paper and install it as shown on page 12.
After several months, old printouts become blurry.	Use thermal printing paper with a longer retention period.
	Store paper at room temperature (about 20°C /68° F).

Software and Firmware

Cyber security best practices include keeping your device apps and OS up to date. To help, Honeywell offers maintenance patches, security updates and operating system upgrades.

Availability and cost depend on the following:

- Date of purchase of the device or software app.
- Warranty status.
- Service agreement status (devices) or Maintenance plan status (apps).

To learn more about Honeywell Services, go to <https://sps.honeywell.com/us/en/services/productivity/support-services>.

Software Downloads

Product support is available online through [Technical Support](#). Software updates can be accessed through the [Software Downloads portal](#). You will need to create a login account for portal access. Additional information such as purchased date, service agreement number, maintenance plan number, or software license number may be required for downloads.

1. Go to honeywell.com/PSSsoftware-downloads.
2. Create a login account if you have not already created one.
3. Install the Honeywell Download Manager tool. See “Note” on the portal page. This tool is required for downloads.
4. Locate the app or upgrade you want to download in the Software directory.
5. If prompted, enter additional information, and click **Submit**.
6. Select **Download**. Follow the prompts to download the file.

Firmware Upgrades





Check for periodic updates to the printer firmware. The latest version of the firmware is available from the Software Downloads portal (honeywell.com/PSSsoftware-downloads).

You can upgrade the printer firmware using the YuShi Printer Tool (also available from the [Software Downloads](#) portal).

Restore Factory Defaults

You can reset the printer to factory defaults using the user interface.

All parameters will be restored to factory default values and any existing configurations stored on the printer will be erased. The printer will be reset with the factory default configuration.

1. With the printer on, press any button to activate the display.
2. Press the left button to open the main menu.
3. Use the right button to navigate to **DEVICE CONFIG**.
4. Press the  button to select the menu.
5. Use the right button to navigate to **Restore Factory**.
6. Press the  button to select the menu option.
7. Press the  button again to confirm.
8. If a password is enabled (see page 18), use the left and right buttons to enter the password (default is 9999) and press the  button to confirm.

Clean the Printer



Warning: Disconnect the power cord before performing any maintenance on the printer.

To properly maintain the printer, you should clean it regularly. You can clean these parts of the printer:

- Printhead
- Print sensor
- Rubber roller



Caution: To avoid possible personal injury or damage to the printer, never insert any pointed or sharp objects into the printer.



Caution: Use only the cleaning agents specified in this section. Honeywell is not responsible for damage caused by any other cleaning materials used on this printer.



Caution: Ethyl alcohol is a highly flammable, moderately toxic, and mildly irritating substance.

Follow these guidelines for cleaning the printer:

- Always remove the power cord before cleaning.
- Never spray the printer with water. Protect it from water when cleaning the premises.



Caution: Do not spray the printer with water. If you are using a hose to clean the premises in an industrial environment, remove the printer or protect it carefully from spray and moisture.

Clean the Printhead



Caution: The printhead may be hot. Allow the printer to cool before cleaning the printer.

Cleaning the printhead regularly is important for the life of the printhead and for print quality.

1. Turn the printer off and disconnect the power cord, if attached.
2. If the printer has been used recently, wait for the printhead to cool completely.
3. Remove the media.
4. Clean the printer head with a soft cotton swab moistened with ethyl alcohol.

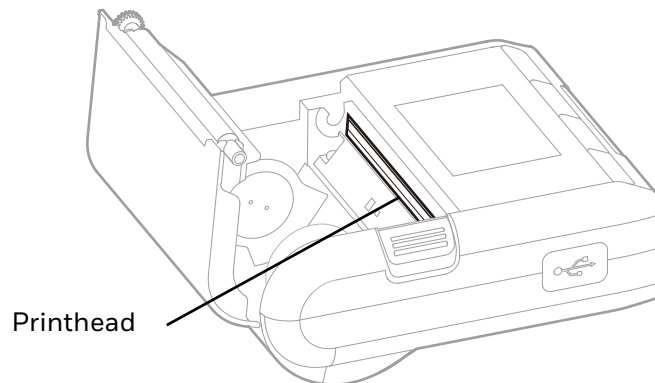

5. Once the print head is completely dry, reinsert the media and close the media door.

Clean the Sensor

1. Turn the printer off and disconnect the power cord, if attached.
2. If the printer has been used recently, wait for the print head to cool completely.
3. Remove the media.
4. Moisten a clean, soft cotton cloth with ethyl alcohol and use it to gently wipe the sensor surface.

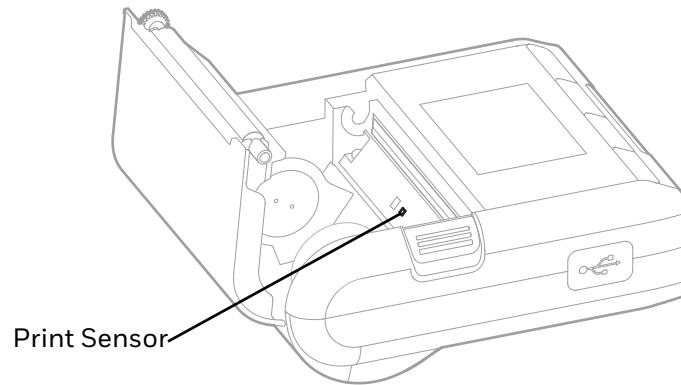

5. Once the sensor is completely dry, reinsert the media and close the media door.

Clean the Rubber Roller

1. Turn the printer off and disconnect the power cord, if attached.
2. If the printer has been used recently, wait for the print head to cool completely.
3. Remove the media.
4. Moisten a clean, soft cotton cloth with a mild detergent solution and use it to wipe the surface of the rubber roller.

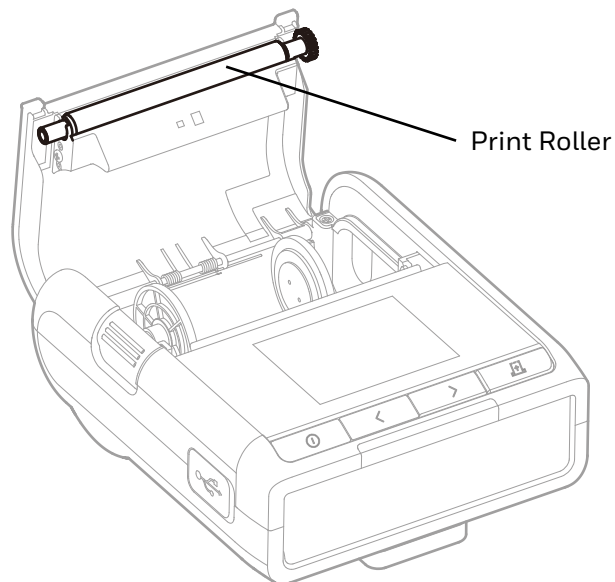

5. Once the roller is completely dry, reinsert the media and close the media door.

SPECIFICATIONS AND ADDITIONAL RESOURCES

Printer and Environmental Specifications

1. Go to sps.honeywell.com and navigate to the LNX3 product page.
2. Select one of the following tabs:
 - **Specifications**
View Printer features, Software, Hardware information, and environmental specifications.
 - **Resources**
View and download available product documentation. For example, Data Sheet, Accessory Guide, Quick Start Guide, User Guide, Regulatory Information, and other product documentation.

Media Specifications

Refer to the data sheet on the LNX3 product page at sps.honeywell.com .

Supported Command Languages

- CPL
- ESC/P
- ESC/POS
- XSIM
- ZPL

Barcode Symbologies

CPCL

1D Barcode Symbologies

- Codabar
- Code 39
- Code 93/Ext. 93
- Code 128
- EAN8
- EAN13
- EAN/JAN-8
- EAN/JAN-13
- German Post Code
- Interleaved 2 of 5
- Industrial 2 of 5
- MSI/Plessey
- UPC-A
- UPC-E

2D Barcode Symbologies

- Aztec
- MaxiCode
- PDF417
- QR Code

ESC/P

1D Barcode Symbologies

- Codabar
- Code 39
- Code 128
- EAN-8
- EAN-13

- EAN-18
- Interleaved 2 of 5
- UPC-A

2D Barcode Symbologies

- Aztec
- PDF417
- QR Code

ESC/POS

1D Barcode Symbologies

- Codabar
- Code 11
- Code 39
- Code 93
- Code 128
- EAN8
- EAN13
- Interleaved 2 of 5
- MSI
- UPC-A
- UPC-E

2D Barcode Symbologies

- MAXICODE
- PDF417
- QR Code

XSim

1D Barcode Symbologies

- Codabar
- Code 39
- Code 128

- EAN/UPC
- Interleaved 2 of 5

2D Barcode Symbologies

- PDF417
- QR Code

ZPL

1D Barcode Symbologies

- ANSI Codabar
- Code 11
- Code 39
- Code 93
- Code128
- EAN-13
- EAN-8
- Industrial 2 of 5
- Interleaved 2 of 5
- LOGMARS
- MSI
- Plessey
- Standard 2 of 5
- UPC-A
- UPC-E
- UPC/EAN Extensions

2D Barcode Symbologies

- Aztec
- PDF417
- QR Code
- UPS MaxiCode

Graphic File Types

CCPL

- Bitmap Graphics
- Compressed Graphics

ESC/P

- Bitmap Graphics
- Compressed Graphics

ESC/POS

- Bitmap Graphics

XSim

- Bitmap Graphics
- Compressed Graphics

ZPL

- Bitmap Graphics
- Compressed Graphics

Character Sets

CPCL

- Latin
- Optional: Simplified Chinese, Traditional Chinese, Japanese, Korean, Arabic and Thai

ESC/P (Easy Print, Line Print)

- Arabic, Cyrillic, Greek, Thai and Hebrew

ESC/POS

- Most Code Page

XSim

- Latin

ZPL-II

- Latin
- Optional: Simplified Chinese, Traditional, Chinese, Japanese, Korean, Arabic and Thai

Required Safety Labels

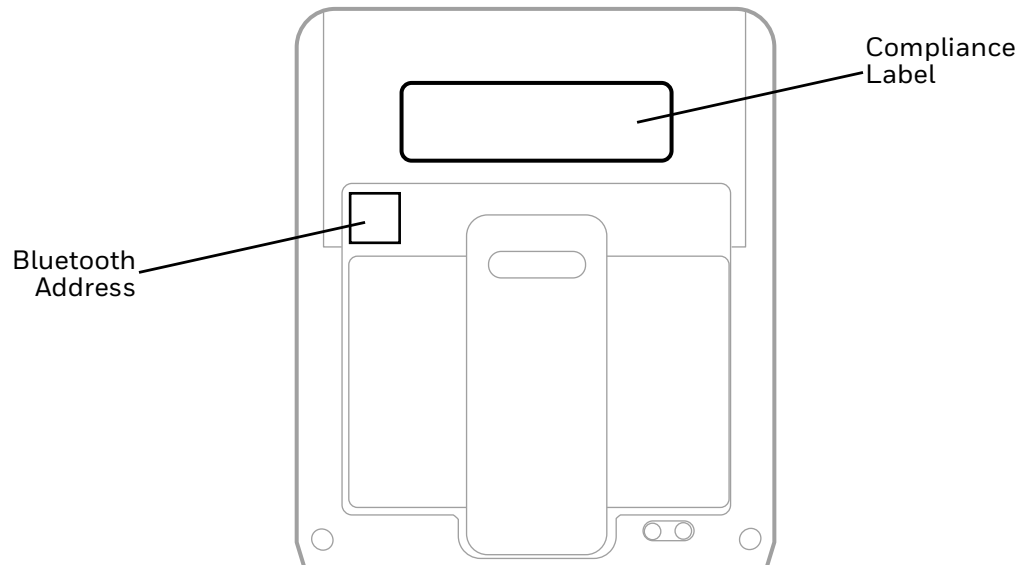

Honeywell
855 S. Mint Street
Charlotte, NC 28202

sps.honeywell.com